



Capacitor-Free, 150-mA, Low-Dropout Regulator with Foldback Current Limit for Portable Devices

 Check for Samples: [TLV713](#), [TLV713P](#)

FEATURES

- **Stable Operation With or Without Capacitors**
- **Foldback Overcurrent Protection**
- **Package: SOT23-5 and X2SON**
- **Very Low Dropout: 230 mV at 150 mA**
- **Accuracy: 1%**
- **Low I_Q : 50 μ A**
- **Input Voltage Range: 1.4 V to 5.5 V**
- **Available in Fixed-Output Voltages: 1.0 V to 3.3 V**
- **High PSRR: 70 dB at 1 kHz**

APPLICATIONS

- **PDAs and Battery-Powered Portable Devices**
- **MP3 Players and Other Hand-Held Products**
- **WLAN and Other PC Add-On Cards**

DESCRIPTION

The TLV713 series of low-dropout (LDO) linear regulators are low quiescent current LDOs with excellent line and load transient performance and are designed for power-sensitive applications. These devices provide a typical accuracy of 1%.

The TLV713 series is designed to be stable without an output capacitor. The removal of the output capacitor allows for a very small solution size. However, the TLV713 series is also stable with any output capacitor if an output capacitor is used.

The TLV713 also provides inrush current control during device power-up and enabling. The TLV713 limits the input current to the defined current limit to avoid large currents from flowing from the input power source. This functionality is especially important in battery-operated devices.

The TLV713 series is available in standard DQN, DPW, and DBV packages. The TLV713P provides an active pull-down circuit to quickly discharge output loads.

DQN Package
1-mm x 1-mm X2SON
(Top View)

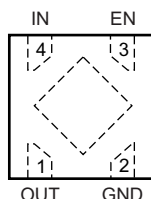

DPW Package
0,8-mm x 0,8-mm X2SON
(Top View)

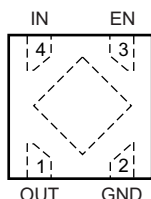

DBV PACKAGE
SOT23-5
(Top View)

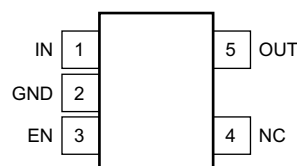

NOTE: DPW version is a Product Preview device.



Please be aware that an important notice concerning availability, standard warranty, and use in critical applications of Texas Instruments semiconductor products and disclaimers thereto appears at the end of this data sheet.

All trademarks are the property of their respective owners.



This integrated circuit can be damaged by ESD. Texas Instruments recommends that all integrated circuits be handled with appropriate precautions. Failure to observe proper handling and installation procedures can cause damage.

ESD damage can range from subtle performance degradation to complete device failure. Precision integrated circuits may be more susceptible to damage because very small parametric changes could cause the device not to meet its published specifications.

ORDERING INFORMATION⁽¹⁾⁽²⁾

PRODUCT	V _{OUT}
TLV713xx(x)Pyyy ⁽³⁾	<p>XX(X) is the nominal output voltage. For output voltages with a resolution of 100 mV, two digits are used in the ordering number; otherwise, three digits are used (for example, 28 = 2.8 V; 475 = 4.75 V).</p> <p>P is optional; devices with P have an LDO regulator with an active output discharge.</p> <p>YYY is the package designator.</p> <p>Z is the package quantity. R is for reel (3000 pieces), T is for tape (250 pieces).</p>

- (1) For the most current package and ordering information see the Package Option Addendum at the end of this document, or visit the device product folder on www.ti.com.
- (2) Output voltages from 1.0 V to 3.3 V in 50-mV increments are available. Contact the factory for details and availability.
- (3) DPW version is a Product Preview device.

ABSOLUTE MAXIMUM RATINGS⁽¹⁾

At T_J = +25°C, unless otherwise noted. All voltages are with respect to GND.

		VALUE		UNIT
		MIN	MAX	
Voltage	Input range, V _{IN}	-0.3	6.0	V
	Enable range, V _{EN}	-0.3	V _{IN} + 0.3	V
	Output range, V _{OUT}	-0.3	6.0	V
Current	Maximum output, I _{OUT}	Internally limited		
Output short-circuit duration		Indefinite		
Total power dissipation	Continuous, P _{DISS}	See Thermal Information table		
Temperature	Junction range, T _J	-55	+85	°C
	Storage junction range, T _{sig}	-55	+150	°C
Electrostatic discharge (ESD) ratings	Human body model (HBM)		2000	V
	Charged device model (CDM)		500	V

- (1) Stresses beyond those listed under *Absolute Maximum Ratings* may cause permanent damage to the device. These are stress ratings only, and functional operation of the device at these or any other conditions beyond those indicated is not implied. Exposure to absolute-maximum rated conditions for extended periods may affect device reliability.

THERMAL INFORMATION

THERMAL METRIC ⁽¹⁾		TLV713xx TLV713xxP			UNITS
		DQN (X2SON)	DPW (X2SON)	DBV (SOT23)	
		4 PINS	4 PINS	5 PINS	
θ _{JA}	Junction-to-ambient thermal resistance	255.8	249.4	213.1	°C/W
θ _{JC(top)}	Junction-to-case(top) thermal resistance	159.3	183.4	110.9	
θ _{JB}	Junction-to-board thermal resistance	208.2	203.5	97.4	
ψ _{JT}	Junction-to-top characterization parameter	16.2	14.5	22.0	
ψ _{JB}	Junction-to-board characterization parameter	208.1	203.3	78.4	
θ _{JC(bottom)}	Junction-to-case(bottom) thermal resistance	148.6	152.5	n/a	

- (1) For more information about traditional and new thermal metrics, see the *IC Package Thermal Metrics* application report, [SPRA953](#).

ELECTRICAL CHARACTERISTICS

At operating temperature range ($T_A = -40^\circ\text{C}$ to $+85^\circ\text{C}$), $T_A = +25^\circ\text{C}$, $V_{IN} = V_{OUT(NOM)} + 0.5\text{ V}$ or 2.0 V (whichever is greater), $I_{OUT} = 1\text{ mA}$, $V_{EN} = V_{IN}$, and $C_{OUT} = 0.47\text{ }\mu\text{F}$, unless otherwise noted.

PARAMETER	TEST CONDITIONS	TLV713			UNIT	
		MIN	TYP	MAX		
V_{IN}	Input voltage range	1.4		5.5	V	
V_{OUT}	Output voltage range	1.0		3.3	V	
DC output accuracy	$V_{OUT} \geq 1.8\text{ V}$, $T_A = +25^\circ\text{C}$	-1		1	%	
	$V_{OUT} < 1.8\text{ V}$, $T_A = +25^\circ\text{C}$	-20		20	mV	
	$V_{OUT} \geq 1.2\text{ V}$, $-40^\circ\text{C} \leq T_A \leq +85^\circ\text{C}$	-1.5		1.5	%	
	$V_{OUT} < 1.2\text{ V}$, $-40^\circ\text{C} \leq T_A \leq +85^\circ\text{C}$	-50		50	mV	
$\Delta V_O/V_{IN}$	Line regulation		1	5	mV	
$\Delta V_O/I_{OUT}$	Load regulation	0 mA $\leq I_{OUT} \leq$ 150 mA		10	30	mV
V_{DO}	Dropout voltage	$V_{OUT} = 0.98 \times V_{OUT(NOM)}$	$1.8\text{ V} \leq V_{OUT} < 2.1\text{ V}$, $I_{OUT} = 30\text{ mA}$	70		mV
			$1.8\text{ V} \leq V_{OUT} < 2.1\text{ V}$, $I_{OUT} = 150\text{ mA}$	350	575	mV
			$2.1\text{ V} \leq V_{OUT} < 2.5\text{ V}$, $I_{OUT} = 30\text{ mA}$	90		mV
			$2.1\text{ V} \leq V_{OUT} < 2.5\text{ V}$, $I_{OUT} = 150\text{ mA}$	290	481	mV
			$2.5\text{ V} \leq V_{OUT} < 3.0\text{ V}$, $I_{OUT} = 30\text{ mA}$	50		mV
			$2.5\text{ V} \leq V_{OUT} < 3.0\text{ V}$, $I_{OUT} = 150\text{ mA}$	246	445	mV
			$3.3\text{ V} \leq V_{OUT} < 3.6\text{ V}$, $I_{OUT} = 30\text{ mA}$	46		mV
			$3.3\text{ V} \leq V_{OUT} < 3.6\text{ V}$, $I_{OUT} = 150\text{ mA}$	230	420	mV
	$1.2\text{ V} \leq V_{OUT} < 1.8\text{ V}$, $I_{OUT} = 150\text{ mA}$	600	900	mV		
I_{GND}	Ground pin current	$I_{OUT} = 0\text{ mA}$		50	75	μA
I_{SHDN}	Shutdown current	$V_{EN} \leq 0.4\text{ V}$, $2.0\text{ V} \leq V_{IN} \leq 5.5\text{ V}$, $T_A = +25^\circ\text{C}$		0.1	1	μA
PSRR	Power-supply rejection ratio	$V_{IN} = 3.3\text{ V}$, $V_{OUT} = 2.8\text{ V}$, $I_{OUT} = 30\text{ mA}$	$f = 100\text{ Hz}$	70		dB
			$f = 10\text{ kHz}$	55		dB
			$f = 1\text{ MHz}$	55		dB
V_{NOISE}	Output noise voltage	BW = 100 Hz to 100 kHz, $V_{IN} = 2.3\text{ V}$, $V_{OUT} = 1.8\text{ V}$, $I_{OUT} = 10\text{ mA}$		55		μV_{RMS}
t_{STR}	Startup time ⁽¹⁾	$C_{OUT} = 1.0\text{ }\mu\text{F}$, $I_{OUT} = 150\text{ mA}$		100		μs
V_{HI}	Enable high (enabled)	0.9		V_{IN}		V
V_{LO}	Enable low (disabled)	0		0.4		V
I_{EN}	EN pin current	EN = 5.5 V		0.01		μA
$R_{PULLDOWN}$	Pull-down resistor (TLV713P only)	$V_{IN} = 4\text{ V}$		120		Ω
T_J	Operating junction temperature	-40		+125		$^\circ\text{C}$
I_{LIM}	Output current limit	$V_{IN} = 3.8\text{ V}$, $V_{OUT} = 3.3\text{ V}$		180		mA
		$V_{IN} = 2.25\text{ V}$, $V_{OUT} = 1.8\text{ V}$		180		mA
		$V_{IN} = 2.0\text{ V}$, $V_{OUT} = 1.2\text{ V}$		180		mA
I_{SC}	Short-circuit current	$V_{OUT} = 0\text{ V}$		40		mA
T_{SD}	Thermal shutdown	Shutdown, temperature increasing		158		$^\circ\text{C}$
		Reset, temperature decreasing		140		$^\circ\text{C}$

(1) Startup time is the time from EN assertion to $(0.98 \times V_{OUT(nom)})$.

PIN CONFIGURATIONS

DQN PACKAGE
1-mm × 1-mm X2SON
(Top View)

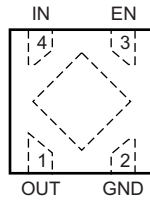

DPW PACKAGE
0,8-mm × 0,8-mm X2SON
(Top View)

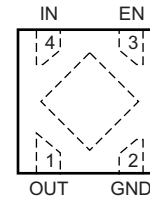

DBV PACKAGE
SOT23-5
(Top View)

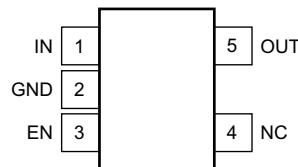

PIN DESCRIPTIONS

PIN			DESCRIPTION
NAME	DQN, DPW	SOT23-5	
EN	3	3	Enable pin. Driving EN over 0.9 V turns on the regulator. Driving EN below 0.4 V puts the regulator into shutdown mode.
GND	2	2	Ground pin
IN	4	1	Input pin. A small capacitor is recommended from this pin to ground. See the Input and Output Capacitor Requirements section in the Application Information for more details.
NC	—	4	No internal connection
OUT	1	5	Regulated output voltage pin. For best transient response, a small 1- μ F ceramic capacitor is recommended from this pin to ground. See the Input and Output Capacitor Requirements section in the Application Information for more details.
Thermal pad	—	—	TI recommends connecting this pin to GND for improved thermal performance.

FUNCTIONAL BLOCK DIAGRAMS

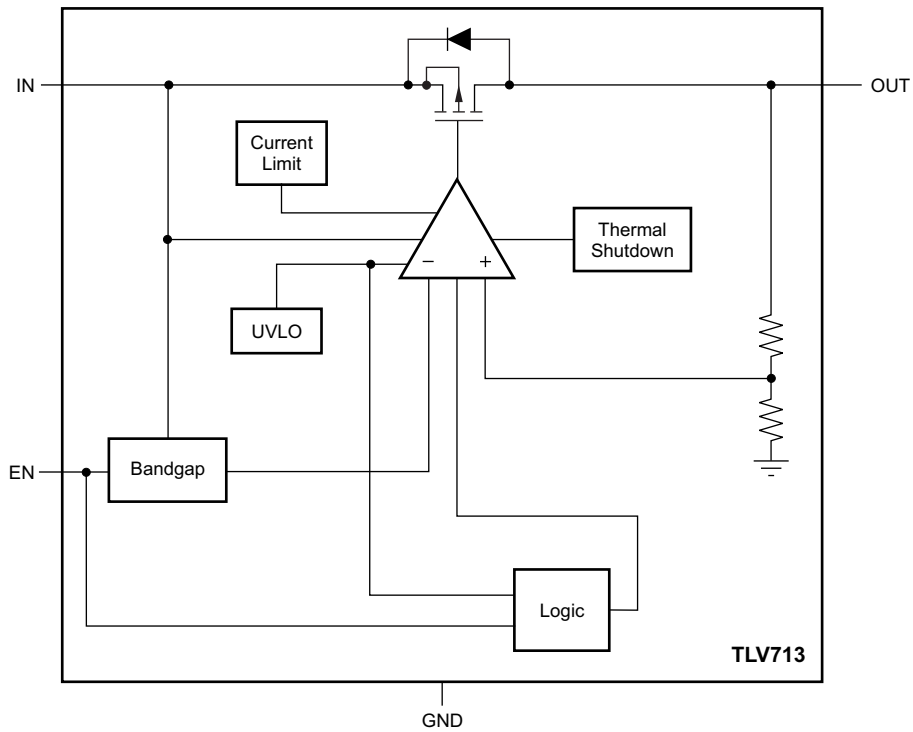

Figure 1. TLV713 Block Diagram

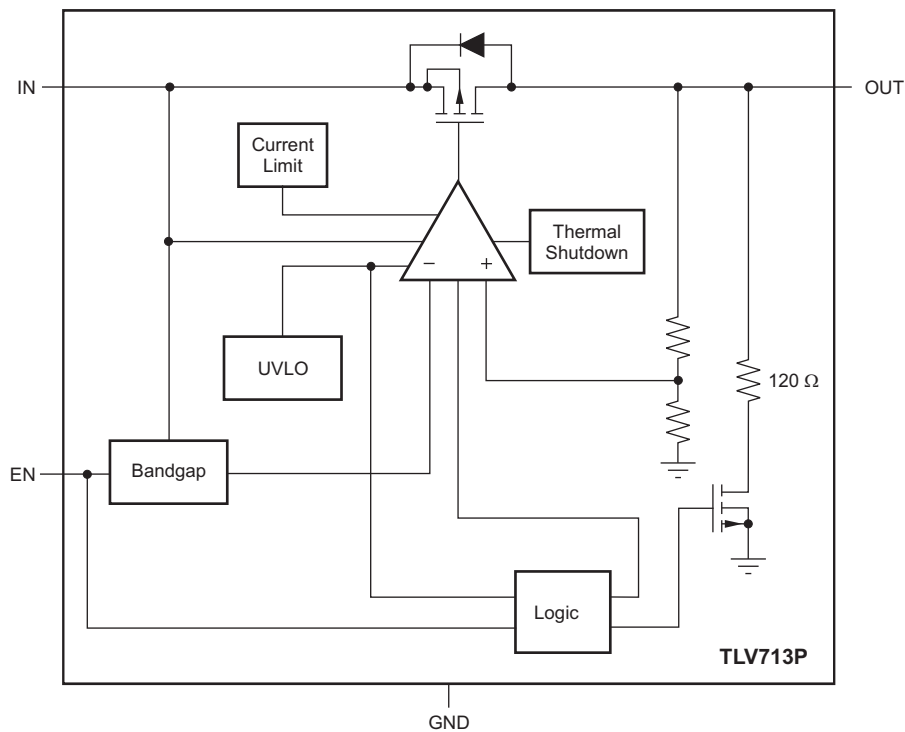

Figure 2. TLV713P Block Diagram

TYPICAL CHARACTERISTICS

At operating temperature range ($T_A = -40^{\circ}\text{C}$ to $+85^{\circ}\text{C}$), $T_A = +25^{\circ}\text{C}$, $V_{IN} = V_{OUT(NOM)} + 0.5\text{ V}$ or 2.0 V (whichever is greater), $I_{OUT} = 10\text{ mA}$, $V_{EN} = V_{IN}$, and $C_{OUT} = 1\text{ }\mu\text{F}$, unless otherwise noted.

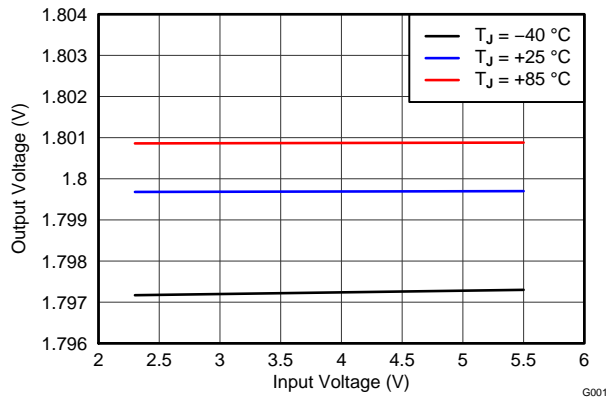

Figure 3. 1.8-V LINE REGULATION vs V_{IN} AND TEMPERATURE

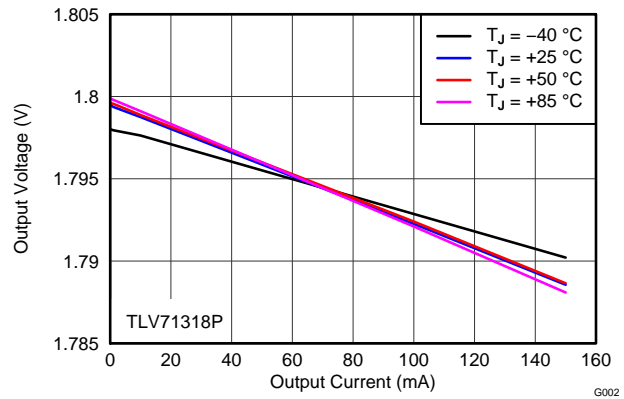

Figure 4. 1.8-V LOAD REGULATION vs I_{OUT} AND TEMPERATURE

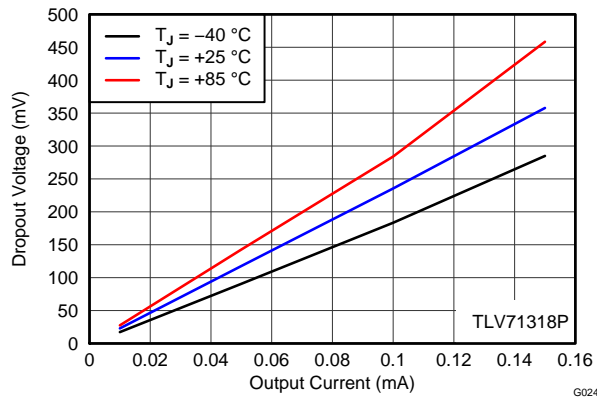

Figure 5. 1.8-V DROPOUT VOLTAGE vs I_{OUT} AND TEMPERATURE

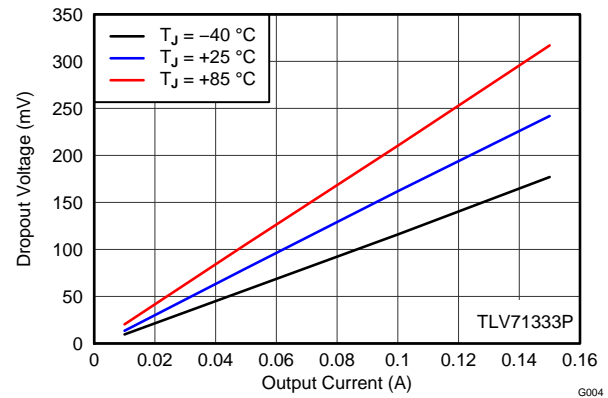

Figure 6. 3.3-V DROPOUT VOLTAGE vs I_{OUT} AND TEMPERATURE

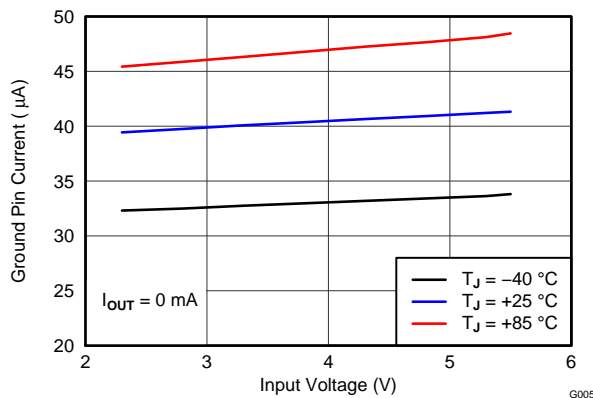

Figure 7. GROUND PIN CURRENT vs V_{IN} AND TEMPERATURE

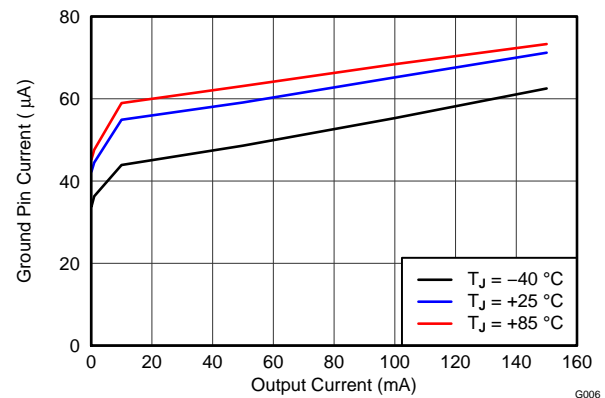

Figure 8. GROUND PIN CURRENT vs I_{OUT} AND TEMPERATURE

TYPICAL CHARACTERISTICS (continued)

At operating temperature range ($T_A = -40^\circ\text{C}$ to $+85^\circ\text{C}$), $T_A = +25^\circ\text{C}$, $V_{IN} = V_{OUT(NOM)} + 0.5\text{ V}$ or 2.0 V (whichever is greater), $I_{OUT} = 10\text{ mA}$, $V_{EN} = V_{IN}$, and $C_{OUT} = 1\text{ }\mu\text{F}$, unless otherwise noted.

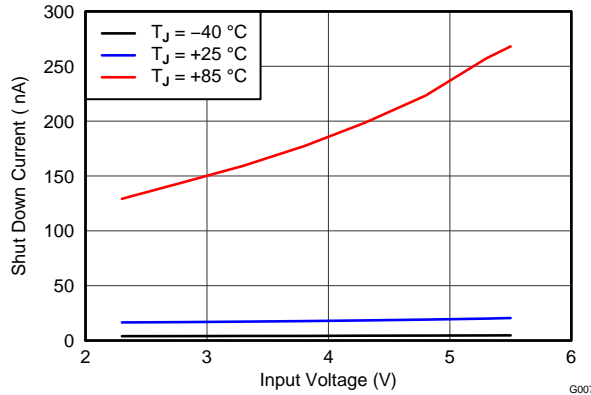

Figure 9. SHUTDOWN CURRENT vs V_{IN} AND TEMPERATURE

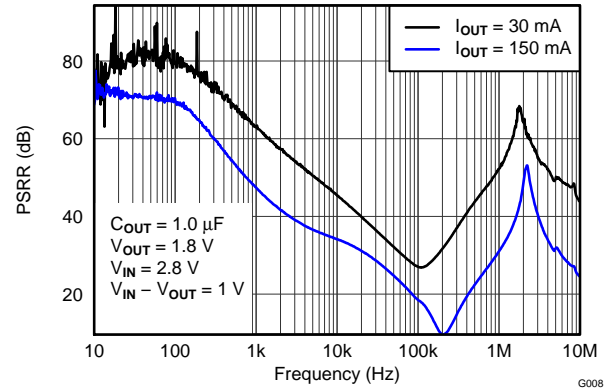

Figure 10. POWER-SUPPLY REJECTION RATIO vs FREQUENCY

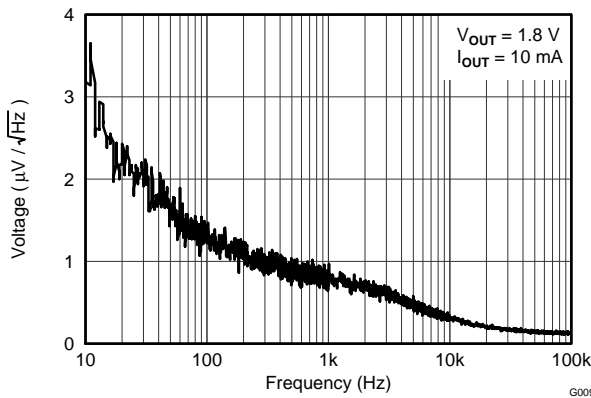

Figure 11. OUTPUT SPECTRAL NOISE DENSITY

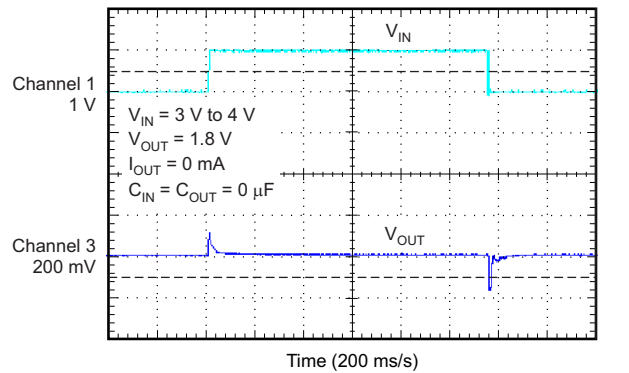

Figure 12. LINE TRANSIENT

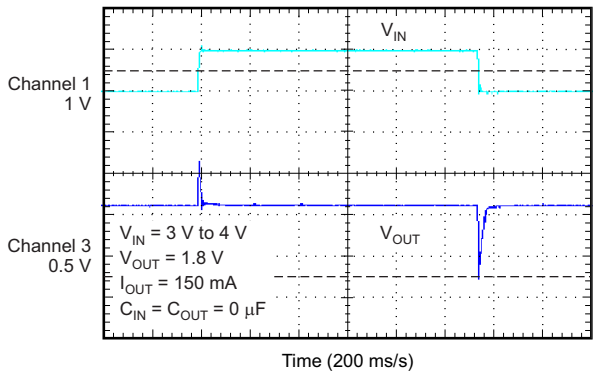

Figure 13. LINE TRANSIENT

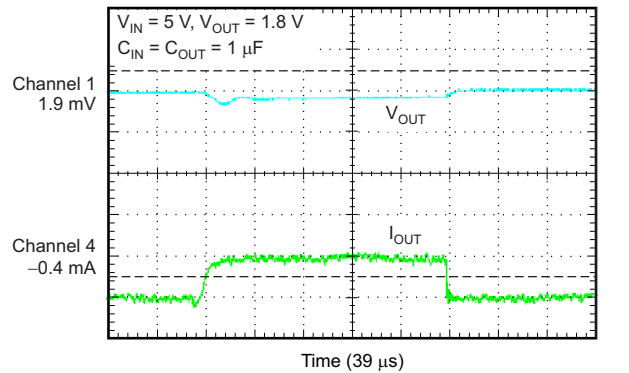

Figure 14. 0-mA to 20-mA LOAD TRANSIENT

TYPICAL CHARACTERISTICS (continued)

At operating temperature range ($T_A = -40^{\circ}\text{C}$ to $+85^{\circ}\text{C}$), $T_A = +25^{\circ}\text{C}$, $V_{IN} = V_{OUT(NOM)} + 0.5\text{ V}$ or 2.0 V (whichever is greater), $I_{OUT} = 10\text{ mA}$, $V_{EN} = V_{IN}$, and $C_{OUT} = 1\ \mu\text{F}$, unless otherwise noted.

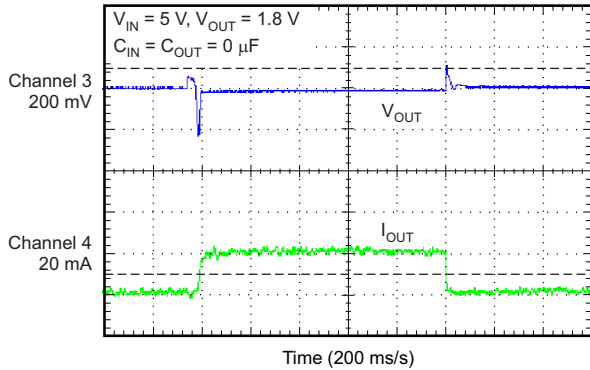

Figure 15. 0-mA to 20-mA LOAD TRANSIENT

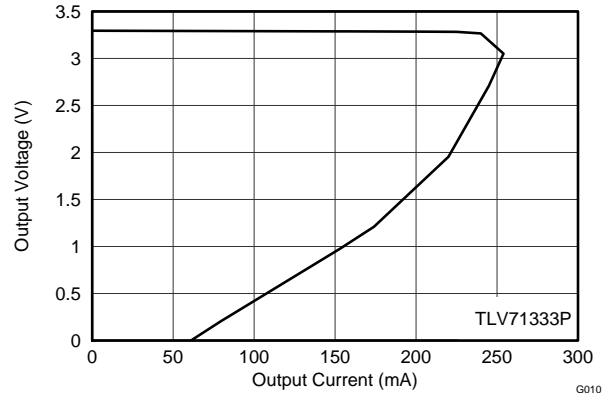

Figure 16. 3.3-V OUTPUT VOLTAGE vs OUTPUT CURRENT (Foldback Current Limit)

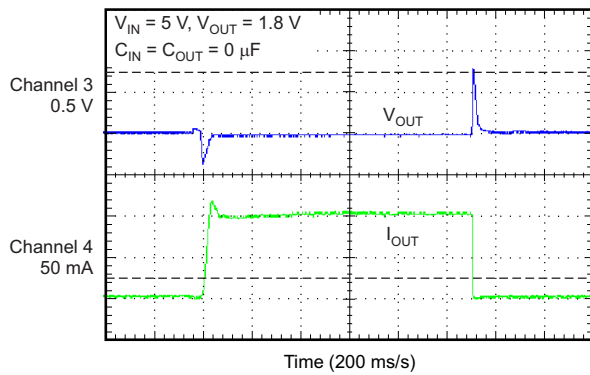

Figure 17. 0-mA to 100-mA LOAD TRANSIENT

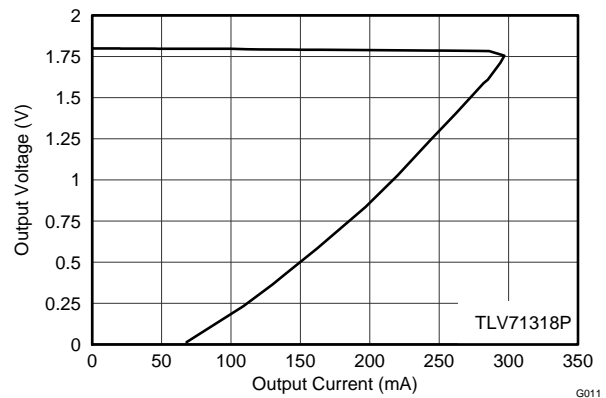

Figure 18. 1.8-V OUTPUT VOLTAGE vs OUTPUT CURRENT (Foldback Current Limit)

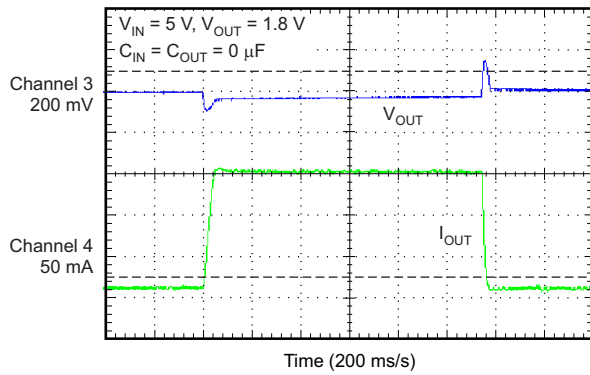

Figure 19. 10-mA to 150-mA LOAD TRANSIENT

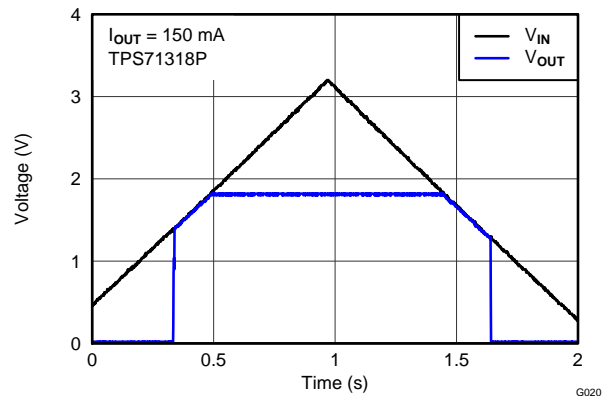

Figure 20. V_{IN} POWER-UP AND POWER-DOWN

TYPICAL CHARACTERISTICS (continued)

At operating temperature range ($T_A = -40^{\circ}\text{C}$ to $+85^{\circ}\text{C}$), $T_A = +25^{\circ}\text{C}$, $V_{IN} = V_{OUT(NOM)} + 0.5\text{ V}$ or 2.0 V (whichever is greater), $I_{OUT} = 10\text{ mA}$, $V_{EN} = V_{IN}$, and $C_{OUT} = 1\text{ }\mu\text{F}$, unless otherwise noted.

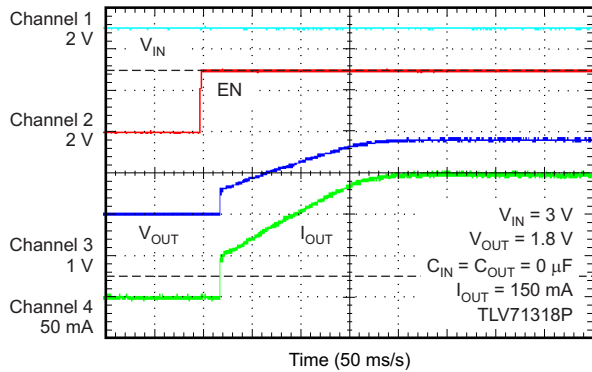

Figure 21. STARTUP WITH EN

G021

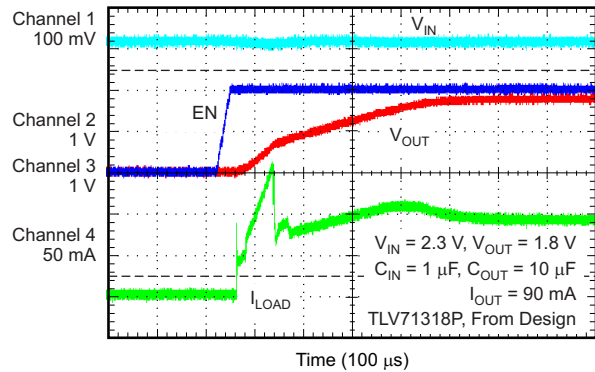

Figure 22. STARTUP WITH EN

G022

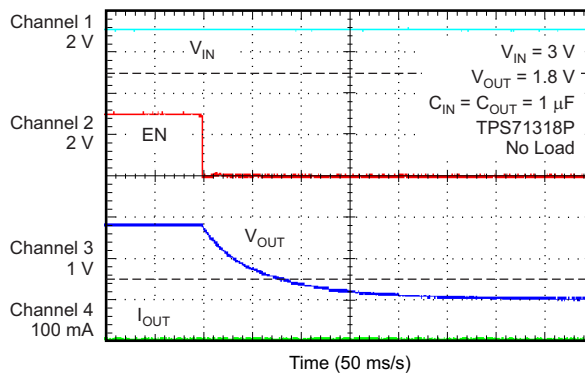

Figure 23. SHUTDOWN RESPONSE WITH ENABLE

G019

APPLICATION INFORMATION

The TLV713 belongs to a new family of next-generation value low-dropout (LDO) regulators. These devices consume low quiescent current and deliver excellent line and load transient performance. These characteristics, combined with low noise, very good PSRR with little ($V_{IN} - V_{OUT}$) headroom, make this family of devices ideal for RF portable applications.

This family of regulators offers current limit and thermal protection. Device operating junction temperature is -40°C to $+85^{\circ}\text{C}$.

INPUT AND OUTPUT CAPACITOR CONSIDERATIONS

The TLV713 uses an advanced internal control loop to obtain stable operation both with and without the use of input or output capacitors. The TLV713xx dynamic performance is improved with the use of an output capacitor. An output capacitance of 0.1 μF or larger generally provides good dynamic response. X5R- and X7R-type ceramic capacitors are recommended because these capacitors have minimal variation in value and equivalent series resistance (ESR) over temperature.

Although an input capacitor is not required for stability, it is good analog design practice to connect a 0.1- μF to 1- μF capacitor from IN to GND. This capacitor counteracts reactive input sources and improves transient response, input ripple, and PSRR. An input capacitor is recommended if the source impedance is more than 0.5 Ω . A higher-value capacitor may be necessary if large, fast, rise-time load transients are anticipated or if the device is located several inches from the input power source.

BOARD LAYOUT RECOMMENDATIONS TO IMPROVE PSRR AND NOISE PERFORMANCE

Input and output capacitors should be placed as close to the device pins as possible. To improve ac performance (such as PSRR, output noise, and transient response), TI recommends that the board be designed with separate ground planes for V_{IN} and V_{OUT} , with the ground plane connected only at the device GND pin. In addition, the output capacitor ground connection should be connected directly to the device GND pin. High ESR capacitors may degrade PSRR performance.

INTERNAL CURRENT LIMIT

The TLV713 has an internal foldback current limit that helps protect the regulator during fault conditions. The current supplied by the device is gradually throttled down while the output voltage decreases. When the output is shorted, the LDO supplies a typical current of 40 mA. Output voltage is not regulated when the device is in current limit, and is ($V_{OUT} = I_{LIMIT} \times R_{LOAD}$). The PMOS pass transistor dissipates $[(V_{IN} - V_{OUT}) \times I_{LIMIT}]$ until thermal shutdown is triggered and the device turns off. While the device cools down, it is turned on by the internal thermal shutdown circuit. If the fault condition continues, the device cycles between current limit and thermal shutdown. See the [Thermal Information](#) section for more details.

The TLV713 PMOS pass element has a built-in body diode that conducts current when the voltage at OUT exceeds the voltage at IN. This current is not limited, so if extended reverse voltage operation is anticipated, external limiting to 5% of the rated output current is recommended.

SHUTDOWN

The enable pin (EN) is active high. The device is enabled when the voltage at the EN pin goes above 0.9 V. This relatively lower voltage value required to turn the LDO on can be exploited to power the LDO with a GPIO of recent processors whose GPIO logic 1 voltage level is lower than traditional microcontrollers. The device is turned off when the EN pin is held at less than 0.4 V. When shutdown capability is not required, EN can be connected to the IN pin.

POWERING THE MSP430 MICROCONTROLLER

Figure 24 shows a diagram of the TLV713 powering an MSP430 microcontroller. Several versions of the TPS713 are ideal for powering the MSP430 microcontroller. Table 1 shows potential applications of some voltage versions.

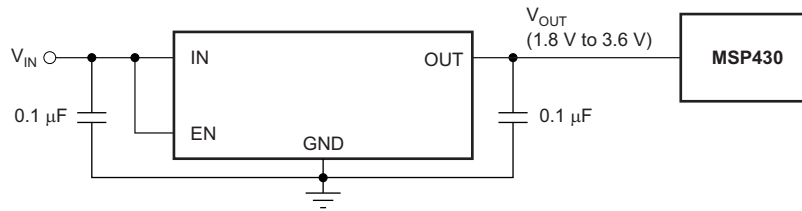

Figure 24. TLV713 Powering a Microcontroller

Table 1. Typical MSP430 Applications

DEVICE	V _{OUT} (Typ)	APPLICATION
TLV71319	1.9 V	V _{OUT} , minimum > 1.8 V required by many MSP430s, allows lowest power consumption operation
TLV71323	2.3 V	V _{OUT} , minimum > 2.2 V required by some MSP430s FLASH operation
TLV71330	3.0 V	V _{OUT} , minimum > 2.7 V required by some MSP430s FLASH operation

DROPOUT VOLTAGE

The TLV713 uses a PMOS pass transistor to achieve low dropout. When ($V_{IN} - V_{OUT}$) is less than the dropout voltage (V_{DO}), the PMOS pass device is in the linear region of operation and the input-to-output resistance is the $R_{DS(ON)}$ of the PMOS pass element. V_{DO} scales approximately with output current because the PMOS device behaves like a resistor in dropout. As with any linear regulator, PSRR and transient response are degraded as ($V_{IN} - V_{OUT}$) approaches dropout.

TRANSIENT RESPONSE

As with any regulator, increasing the size of the output capacitor reduces over- and undershoot magnitude but increases the duration of the transient response.

UNDERVOLTAGE LOCKOUT (UVLO)

The TLV713 uses an undervoltage lockout (UVLO) circuit to keep the output shut off until the internal circuitry operates properly.

THERMAL INFORMATION

Thermal protection disables the output when the junction temperature rises to approximately +160°C, allowing the device to cool. When the junction temperature cools to approximately +140°C, the output circuitry is again enabled. Depending on power dissipation, thermal resistance, and ambient temperature, the thermal protection circuit may cycle on and off. This cycling limits regulator dissipation, protecting it from damage as a result of overheating.

Any tendency to activate the thermal protection circuit indicates excessive power dissipation or an inadequate heatsink. For reliable operation, junction temperature should be limited to +125°C maximum. To estimate the margin of safety in a complete design (including heatsink), increase the ambient temperature until the thermal protection is triggered; use worst-case loads and signal conditions.

The TLV713 internal protection circuitry is designed to protect against overload conditions. It is not intended to replace proper heatsinking. Continuously running the TLV713 into thermal shutdown degrades device reliability.

POWER DISSIPATION

The ability to remove heat from the die is different for each package type, presenting different considerations in the printed circuit board (PCB) layout. The PCB area around the device that is free of other components moves the heat from the device to ambient air. Performance data for JEDEC-low and high-K boards are given in the [Thermal Information](#) table. Using heavier copper increases the effectiveness in removing heat from the device. The addition, plated through-holes to heat-dissipating layers also improves heatsink effectiveness.

Power dissipation (P_D) depends on input voltage and load conditions. P_D is equal to the product of the output current and voltage drop across the output pass element, as shown in [Equation 1](#).

$$P_D = (V_{IN} - V_{OUT}) \times I_{OUT} \quad (1)$$

REVISION HISTORY

NOTE: Page numbers for previous revisions may differ from page numbers in the current version.

Changes from Revision A (October 2012) to Revision B	Page
• Changed footnote for page 1 graphic	1
• Changed footnote 3 of Ordering Information table	2
• Added DBV data to Thermal Information table	2

Changes from Original (September 2012) to Revision A	Page
• Reordered Features bullets	1
• Changed dropout range in fourth Features bullet	1
• Changed <i>Package</i> and <i>Fixed-Output Voltage</i> Features bullets	1
• Added second and third paragraphs to <i>Description</i> section	1
• Updated DQN pin out drawing	1
• Changed DQN header row in Thermal Information table	2
• Changed V_{OUT} maximum specification in Electrical Characteristics table	3
• Combined all V_{DO} rows together in Electrical Characteristics table	3
• Changed V_{DO} specifications in Electrical Characteristics table	3
• Changed I_{SHDN} test conditions in Electrical Characteristics table	3
• Changed DQN pin out caption in Pin Configurations section	4
• Changed 1.2 V to 0.9 V in description of EN pin in Pin Descriptions table	4
• Updated Figure 1	5
• Changed Typical Characteristics conditions	6
• Added curves	6
• Changed junction temperature range in second paragraph of <i>Application Information</i> section	10
• Changed second paragraph of <i>Input and Output Capacitor Considerations</i> section	10
• Deleted curve reference from <i>Dropout Voltage</i> section	11
• Deleted third paragraph from <i>Thermal Information</i> section	12

PACKAGING INFORMATION

Orderable Device	Status (1)	Package Type	Package Drawing	Pins	Package Qty	Eco Plan (2)	Lead/Ball Finish	MSL Peak Temp (3)	Samples (Requires Login)
TLV71312PDBVR	PREVIEW	SOT-23	DBV	5	3000	Green (RoHS & no Sb/Br)	CU NIPDAU	Level-1-260C-UNLIM	
TLV71312PDBVT	PREVIEW	SOT-23	DBV	5	250	Green (RoHS & no Sb/Br)	CU NIPDAU	Level-1-260C-UNLIM	
TLV71312PDQNR	ACTIVE	X2SON	DQN	4	3000	Green (RoHS & no Sb/Br)	CU NIPDAU	Level-1-260C-UNLIM	
TLV71312PDQNT	ACTIVE	X2SON	DQN	4	250	Green (RoHS & no Sb/Br)	CU NIPDAU	Level-1-260C-UNLIM	
TLV71315PDQNR	PREVIEW	X2SON	DQN	4	3000	Green (RoHS & no Sb/Br)	CU NIPDAU	Level-1-260C-UNLIM	
TLV71315PDQNT	PREVIEW	X2SON	DQN	4	250	Green (RoHS & no Sb/Br)	CU NIPDAU	Level-1-260C-UNLIM	
TLV713185PDQNR	PREVIEW	X2SON	DQN	4	3000	Green (RoHS & no Sb/Br)	CU NIPDAU	Level-1-260C-UNLIM	
TLV713185PDQNT	PREVIEW	X2SON	DQN	4	250	Green (RoHS & no Sb/Br)	CU NIPDAU	Level-1-260C-UNLIM	
TLV71318PDBVR	PREVIEW	SOT-23	DBV	5	3000	Green (RoHS & no Sb/Br)	CU NIPDAU	Level-1-260C-UNLIM	
TLV71318PDBVT	PREVIEW	SOT-23	DBV	5	250	Green (RoHS & no Sb/Br)	CU NIPDAU	Level-1-260C-UNLIM	
TLV71318PDQNR	ACTIVE	X2SON	DQN	4	3000	Green (RoHS & no Sb/Br)	CU NIPDAU	Level-1-260C-UNLIM	
TLV71318PDQNT	ACTIVE	X2SON	DQN	4	250	Green (RoHS & no Sb/Br)	CU NIPDAU	Level-1-260C-UNLIM	
TLV71320DQNR	ACTIVE	X2SON	DQN	4	3000	Green (RoHS & no Sb/Br)	CU NIPDAU	Level-1-260C-UNLIM	
TLV71320DQNT	ACTIVE	X2SON	DQN	4	250	Green (RoHS & no Sb/Br)	CU NIPDAU	Level-1-260C-UNLIM	
TLV71325PDQNR	ACTIVE	X2SON	DQN	4	3000	Green (RoHS & no Sb/Br)	CU NIPDAU	Level-1-260C-UNLIM	
TLV71325PDQNT	ACTIVE	X2SON	DQN	4	250	Green (RoHS & no Sb/Br)	CU NIPDAU	Level-1-260C-UNLIM	
TLV713285PDQNR	PREVIEW	X2SON	DQN	4	3000	Green (RoHS & no Sb/Br)	CU NIPDAU	Level-1-260C-UNLIM	

Orderable Device	Status (1)	Package Type	Package Drawing	Pins	Package Qty	Eco Plan (2)	Lead/Ball Finish	MSL Peak Temp (3)	Samples (Requires Login)
TLV713285PDQNT	PREVIEW	X2SON	DQN	4	250	Green (RoHS & no Sb/Br)	CU NIPDAU	Level-1-260C-UNLIM	
TLV71328PDQNR	PREVIEW	X2SON	DQN	4	3000	Green (RoHS & no Sb/Br)	CU NIPDAU	Level-1-260C-UNLIM	
TLV71328PDQNT	PREVIEW	X2SON	DQN	4	250	Green (RoHS & no Sb/Br)	CU NIPDAU	Level-1-260C-UNLIM	
TLV71330PDQNR	ACTIVE	X2SON	DQN	4	3000	Green (RoHS & no Sb/Br)	CU NIPDAU	Level-1-260C-UNLIM	
TLV71330PDQNT	ACTIVE	X2SON	DQN	4	250	Green (RoHS & no Sb/Br)	CU NIPDAU	Level-1-260C-UNLIM	
TLV71333PDBVR	PREVIEW	SOT-23	DBV	5	3000	Green (RoHS & no Sb/Br)	CU NIPDAU	Level-1-260C-UNLIM	
TLV71333PDBVT	PREVIEW	SOT-23	DBV	5	250	Green (RoHS & no Sb/Br)	CU NIPDAU	Level-1-260C-UNLIM	
TLV71333PDQNR	ACTIVE	X2SON	DQN	4	3000	Green (RoHS & no Sb/Br)	CU NIPDAU	Level-1-260C-UNLIM	
TLV71333PDQNT	ACTIVE	X2SON	DQN	4	250	Green (RoHS & no Sb/Br)	CU NIPDAU	Level-1-260C-UNLIM	

(1) The marketing status values are defined as follows:

ACTIVE: Product device recommended for new designs.

LIFEBUY: TI has announced that the device will be discontinued, and a lifetime-buy period is in effect.

NRND: Not recommended for new designs. Device is in production to support existing customers, but TI does not recommend using this part in a new design.

PREVIEW: Device has been announced but is not in production. Samples may or may not be available.

OBSELETE: TI has discontinued the production of the device.

(2) Eco Plan - The planned eco-friendly classification: Pb-Free (RoHS), Pb-Free (RoHS Exempt), or Green (RoHS & no Sb/Br) - please check <http://www.ti.com/productcontent> for the latest availability information and additional product content details.

TBD: The Pb-Free/Green conversion plan has not been defined.

Pb-Free (RoHS): TI's terms "Lead-Free" or "Pb-Free" mean semiconductor products that are compatible with the current RoHS requirements for all 6 substances, including the requirement that lead not exceed 0.1% by weight in homogeneous materials. Where designed to be soldered at high temperatures, TI Pb-Free products are suitable for use in specified lead-free processes.

Pb-Free (RoHS Exempt): This component has a RoHS exemption for either 1) lead-based flip-chip solder bumps used between the die and package, or 2) lead-based die adhesive used between the die and leadframe. The component is otherwise considered Pb-Free (RoHS compatible) as defined above.

Green (RoHS & no Sb/Br): TI defines "Green" to mean Pb-Free (RoHS compatible), and free of Bromine (Br) and Antimony (Sb) based flame retardants (Br or Sb do not exceed 0.1% by weight in homogeneous material)

(3) MSL, Peak Temp. -- The Moisture Sensitivity Level rating according to the JEDEC industry standard classifications, and peak solder temperature.

Important Information and Disclaimer: The information provided on this page represents TI's knowledge and belief as of the date that it is provided. TI bases its knowledge and belief on information provided by third parties, and makes no representation or warranty as to the accuracy of such information. Efforts are underway to better integrate information from third parties. TI has taken and continues to take reasonable steps to provide representative and accurate information but may not have conducted destructive testing or chemical analysis on incoming materials and chemicals. TI and TI suppliers consider certain information to be proprietary, and thus CAS numbers and other limited information may not be available for release.

In no event shall TI's liability arising out of such information exceed the total purchase price of the TI part(s) at issue in this document sold by TI to Customer on an annual basis.

TAPE AND REEL INFORMATION



QUADRANT ASSIGNMENTS FOR PIN 1 ORIENTATION IN TAPE



*All dimensions are nominal

Device	Package Type	Package Drawing	Pins	SPQ	Reel Diameter (mm)	Reel Width W1 (mm)	A0 (mm)	B0 (mm)	K0 (mm)	P1 (mm)	W (mm)	Pin1 Quadrant
TLV71312PDBVR	SOT-23	DBV	5	3000	178.0	9.0	3.23	3.17	1.37	4.0	8.0	Q3
TLV71312PDQNR	X2SON	DQN	4	3000	180.0	9.5	1.16	1.16	0.63	4.0	8.0	Q2
TLV71312PDQNT	X2SON	DQN	4	250	180.0	9.5	1.16	1.16	0.63	4.0	8.0	Q2
TLV71318PDBVR	SOT-23	DBV	5	3000	178.0	9.0	3.23	3.17	1.37	4.0	8.0	Q3
TLV71318PDQNR	X2SON	DQN	4	3000	180.0	9.5	1.16	1.16	0.63	4.0	8.0	Q2
TLV71318PDQNT	X2SON	DQN	4	250	180.0	9.5	1.16	1.16	0.63	4.0	8.0	Q2
TLV71320DQNR	X2SON	DQN	4	3000	180.0	9.5	1.16	1.16	0.63	4.0	8.0	Q2
TLV71320DQNT	X2SON	DQN	4	250	180.0	9.5	1.16	1.16	0.63	4.0	8.0	Q2
TLV71325PDQNR	X2SON	DQN	4	3000	180.0	9.5	1.16	1.16	0.63	4.0	8.0	Q2
TLV71325PDQNT	X2SON	DQN	4	250	180.0	9.5	1.16	1.16	0.63	4.0	8.0	Q2
TLV71330PDQNR	X2SON	DQN	4	3000	180.0	9.5	1.16	1.16	0.63	4.0	8.0	Q2
TLV71330PDQNT	X2SON	DQN	4	250	180.0	9.5	1.16	1.16	0.63	4.0	8.0	Q2
TLV71333PDBVR	SOT-23	DBV	5	3000	178.0	9.0	3.23	3.17	1.37	4.0	8.0	Q3
TLV71333PDQNR	X2SON	DQN	4	3000	180.0	9.5	1.16	1.16	0.63	4.0	8.0	Q2
TLV71333PDQNT	X2SON	DQN	4	250	180.0	9.5	1.16	1.16	0.63	4.0	8.0	Q2

TAPE AND REEL BOX DIMENSIONS

*All dimensions are nominal

Device	Package Type	Package Drawing	Pins	SPQ	Length (mm)	Width (mm)	Height (mm)
TLV71312PDBVR	SOT-23	DBV	5	3000	180.0	180.0	18.0
TLV71312PDQNR	X2SON	DQN	4	3000	180.0	180.0	30.0
TLV71312PDQNT	X2SON	DQN	4	250	180.0	180.0	30.0
TLV71318PDBVR	SOT-23	DBV	5	3000	180.0	180.0	18.0
TLV71318PDQNR	X2SON	DQN	4	3000	180.0	180.0	30.0
TLV71318PDQNT	X2SON	DQN	4	250	180.0	180.0	30.0
TLV71320DQNR	X2SON	DQN	4	3000	180.0	180.0	30.0
TLV71320DQNT	X2SON	DQN	4	250	180.0	180.0	30.0
TLV71325PDQNR	X2SON	DQN	4	3000	180.0	180.0	30.0
TLV71325PDQNT	X2SON	DQN	4	250	180.0	180.0	30.0
TLV71330PDQNR	X2SON	DQN	4	3000	180.0	180.0	30.0
TLV71330PDQNT	X2SON	DQN	4	250	180.0	180.0	30.0
TLV71333PDBVR	SOT-23	DBV	5	3000	180.0	180.0	18.0
TLV71333PDQNR	X2SON	DQN	4	3000	180.0	180.0	30.0
TLV71333PDQNT	X2SON	DQN	4	250	180.0	180.0	30.0

DBV (R-PDSO-G5)

PLASTIC SMALL-OUTLINE PACKAGE

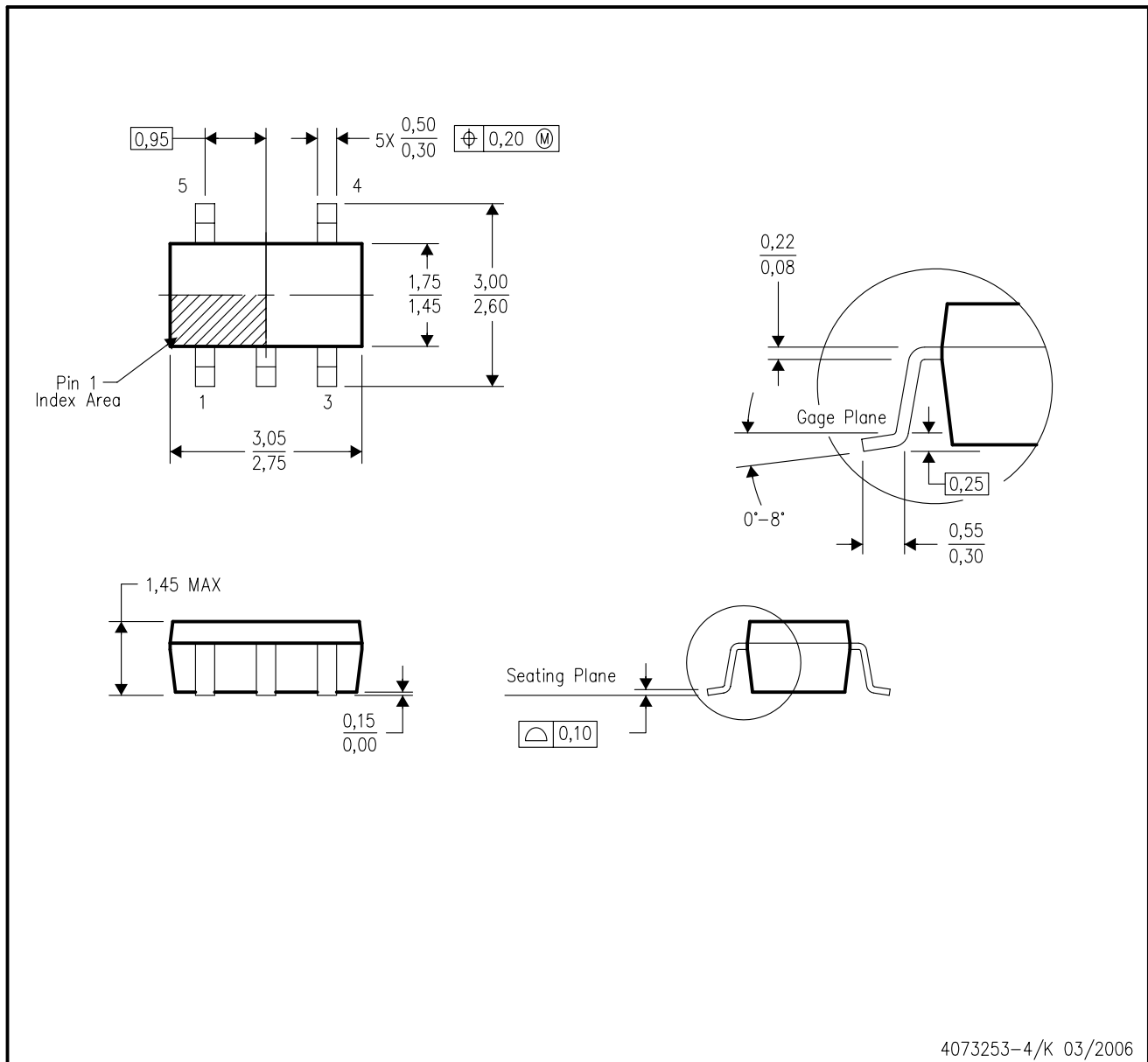

- NOTES:
- A. All linear dimensions are in millimeters.
 - B. This drawing is subject to change without notice.
 - C. Body dimensions do not include mold flash or protrusion. Mold flash and protrusion shall not exceed 0.15 per side.
 - D. Falls within JEDEC MO-178 Variation AA.

DBV (R-PDSO-G5)

PLASTIC SMALL OUTLINE



- NOTES:
- A. All linear dimensions are in millimeters.
 - B. This drawing is subject to change without notice.
 - C. Customers should place a note on the circuit board fabrication drawing not to alter the center solder mask defined pad.
 - D. Publication IPC-7351 is recommended for alternate designs.
 - E. Laser cutting apertures with trapezoidal walls and also rounding corners will offer better paste release. Customers should contact their board assembly site for stencil design recommendations. Example stencil design based on a 50% volumetric metal load solder paste. Refer to IPC-7525 for other stencil recommendations.

DQN (S-PX2SON-N4)

PLASTIC SMALL OUTLINE NO-LEAD

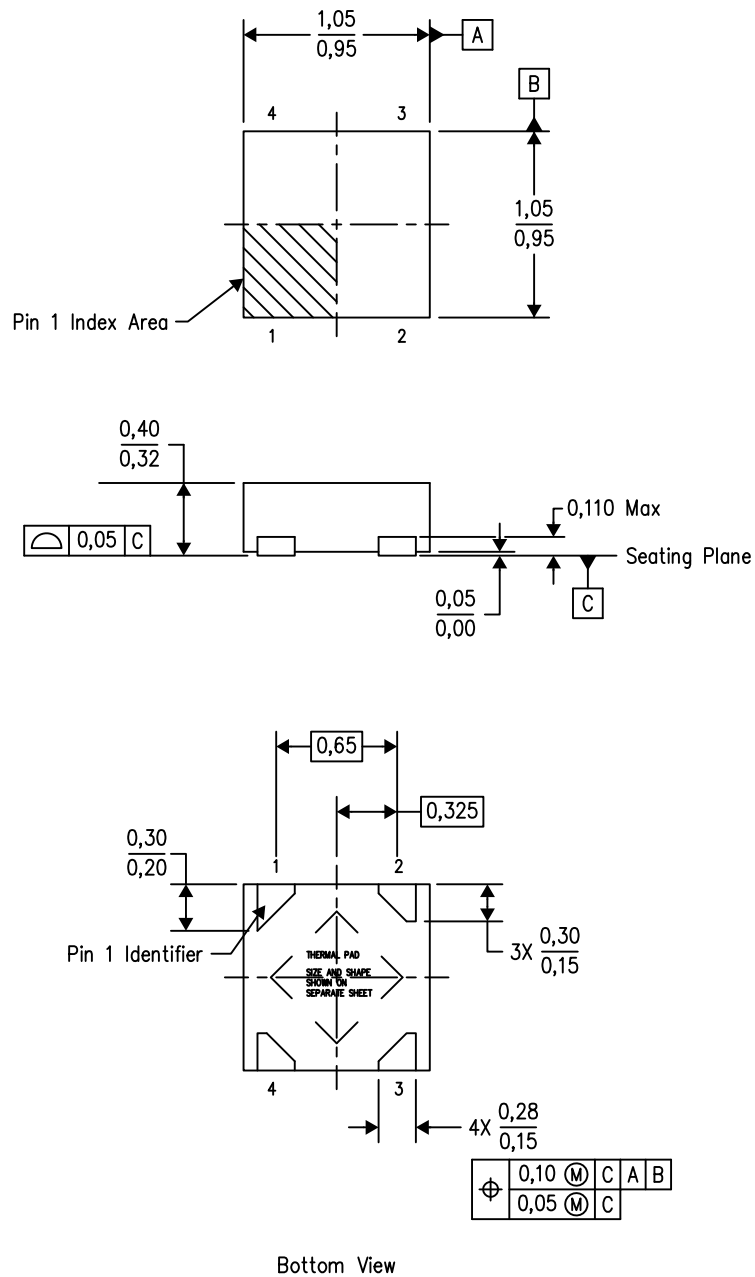

4210367/D 09/2012

- NOTES:
- All linear dimensions are in millimeters. Dimensioning and tolerancing per ASME Y14.5M-1994.
 - This drawing is subject to change without notice.
 - SON (Small Outline No-Lead) package configuration.
 - The package thermal pad must be soldered to the board for thermal and mechanical performance.
 - See the additional figure in the Product Data Sheet for details regarding the exposed thermal pad features and dimensions.

IMPORTANT NOTICE

Texas Instruments Incorporated and its subsidiaries (TI) reserve the right to make corrections, enhancements, improvements and other changes to its semiconductor products and services per JESD46, latest issue, and to discontinue any product or service per JESD48, latest issue. Buyers should obtain the latest relevant information before placing orders and should verify that such information is current and complete. All semiconductor products (also referred to herein as "components") are sold subject to TI's terms and conditions of sale supplied at the time of order acknowledgment.

TI warrants performance of its components to the specifications applicable at the time of sale, in accordance with the warranty in TI's terms and conditions of sale of semiconductor products. Testing and other quality control techniques are used to the extent TI deems necessary to support this warranty. Except where mandated by applicable law, testing of all parameters of each component is not necessarily performed.

TI assumes no liability for applications assistance or the design of Buyers' products. Buyers are responsible for their products and applications using TI components. To minimize the risks associated with Buyers' products and applications, Buyers should provide adequate design and operating safeguards.

TI does not warrant or represent that any license, either express or implied, is granted under any patent right, copyright, mask work right, or other intellectual property right relating to any combination, machine, or process in which TI components or services are used. Information published by TI regarding third-party products or services does not constitute a license to use such products or services or a warranty or endorsement thereof. Use of such information may require a license from a third party under the patents or other intellectual property of the third party, or a license from TI under the patents or other intellectual property of TI.

Reproduction of significant portions of TI information in TI data books or data sheets is permissible only if reproduction is without alteration and is accompanied by all associated warranties, conditions, limitations, and notices. TI is not responsible or liable for such altered documentation. Information of third parties may be subject to additional restrictions.

Resale of TI components or services with statements different from or beyond the parameters stated by TI for that component or service voids all express and any implied warranties for the associated TI component or service and is an unfair and deceptive business practice. TI is not responsible or liable for any such statements.

Buyer acknowledges and agrees that it is solely responsible for compliance with all legal, regulatory and safety-related requirements concerning its products, and any use of TI components in its applications, notwithstanding any applications-related information or support that may be provided by TI. Buyer represents and agrees that it has all the necessary expertise to create and implement safeguards which anticipate dangerous consequences of failures, monitor failures and their consequences, lessen the likelihood of failures that might cause harm and take appropriate remedial actions. Buyer will fully indemnify TI and its representatives against any damages arising out of the use of any TI components in safety-critical applications.

In some cases, TI components may be promoted specifically to facilitate safety-related applications. With such components, TI's goal is to help enable customers to design and create their own end-product solutions that meet applicable functional safety standards and requirements. Nonetheless, such components are subject to these terms.

No TI components are authorized for use in FDA Class III (or similar life-critical medical equipment) unless authorized officers of the parties have executed a special agreement specifically governing such use.

Only those TI components which TI has specifically designated as military grade or "enhanced plastic" are designed and intended for use in military/aerospace applications or environments. Buyer acknowledges and agrees that any military or aerospace use of TI components which have **not** been so designated is solely at the Buyer's risk, and that Buyer is solely responsible for compliance with all legal and regulatory requirements in connection with such use.

TI has specifically designated certain components as meeting ISO/TS16949 requirements, mainly for automotive use. In any case of use of non-designated products, TI will not be responsible for any failure to meet ISO/TS16949.

Products

Audio	www.ti.com/audio
Amplifiers	amplifier.ti.com
Data Converters	dataconverter.ti.com
DLP® Products	www.dlp.com
DSP	dsp.ti.com
Clocks and Timers	www.ti.com/clocks
Interface	interface.ti.com
Logic	logic.ti.com
Power Mgmt	power.ti.com
Microcontrollers	microcontroller.ti.com
RFID	www.ti-rfid.com
OMAP Applications Processors	www.ti.com/omap
Wireless Connectivity	www.ti.com/wirelessconnectivity

Applications

Automotive and Transportation	www.ti.com/automotive
Communications and Telecom	www.ti.com/communications
Computers and Peripherals	www.ti.com/computers
Consumer Electronics	www.ti.com/consumer-apps
Energy and Lighting	www.ti.com/energy
Industrial	www.ti.com/industrial
Medical	www.ti.com/medical
Security	www.ti.com/security
Space, Avionics and Defense	www.ti.com/space-avionics-defense
Video and Imaging	www.ti.com/video

TI E2E Community

e2e.ti.com